

DAKOTA ULTRASONICS

Flaw Detectors, Accessories & Probes - Price List

Date: 09/01/21



Models:	Connector Type	Part #	Price US
DFX-7	LEMO 00	Z-220-0003	3650.00
DFX-7+	LEMO 00	Z-221-0003	3850.00
DFX-8	LEMO 00	Z-250-0001	4850.00
DFX-8+	LEMO 00	Z-251-0001	5850.00

Kit Includes (DFX-7 Series):

Operating Manuals	4 oz Couplant
DakView PC software & USB Cable	Calibration certificate
Carrying case	

Kit Includes (DFX-8 Series):

Lithium ion battery	4 oz Couplant
Line power adaptor	Operating manuals
Universal power cable	DakView PC software & USB cable
Carrying Case	Calibration certificate

Additional Options (DFX-6 Series):

	Part #	Price US
Firmware software upgrade included w/service	Call for RMA	250.00
Firmware software upgrade only	Call for RMA	350.00
WinDFX2 Reporting Software & Cable – USB Interface	F-211-0008	725.00

Additional Options (DFX-7 Series):

	Part #	Price US
Note: All firmware upgrades available for download on our website at no charge.		N/A
DakView PC Software CD (included w/ DFX-7 kits)	A-206-7001	30.00

Additional Options (DFX-8 Series):

	Part #	Price US
Note: All firmware & PC software upgrades available for download on our website at no charge.		N/A
DakView PC Software CD (included w/ DFX-8 kits)	A-206-7001	30.00

Accessory Items (DFX-6 Series):

	Part #	Price US
Lithium ion battery pack	B-020-3100	225.00
External smart battery charger	B-030-0000	245.00
Power adaptor (18 volts 3.9amps w/6' cable)	N-006-0202	95.00
Universal power cable	N-506-0060	15.00
Instrument case (w/straps)	F-211-0007	150.00
Operators manual DFX-615	P-211-0007	35.00

DAKOTA ULTRASONICS

1500 Green Hills Road, #107 Scotts Valley, CA 95066

Phone: (831) 431-9722 Fax: (831) 431-9723 www.dakotaultrasonics.com

Prices subject to change without notice: please call for an updated price list.

Operators manual DFX-625	P-211-0008	35.00
Operators manual DFX-635	P-211-0009	35.00
Operators manual DFX-638	P-211-0010	35.00
Video output cable	152119	75.00
RS232 PC cable (9 pin)	N-406-0750	70.00

Accessory Items (DFX-7 Series):	Part #	Price US
Instrument case (w/straps)	F-149-0001	75.00
Rubber instrument case (w/straps and stand)	A-149-6002	100.00
6 foot RS232 (DB-9 to Lemo 2 pin)	N-306-0010	65.00
USB to Serial Adapter	N-402-0510	25.00
Operators manual DFX-7 Series (Thickness)	P-220-0004	20.00
Operators manual DFX-7 Series (Flaw)	P-220-0002	20.00
Plastic Carrying Brief Case	A-100-6003	35.00
Lemo 00 to BNC Transducer Cable Adapter	J-098-0001	50.00
3' Type C to USB Type A male data cable	N-003-0330	25.00

Accessory Items (DFX-8 Series):	Part #	Price US
Lithium ion battery pack	B-040-3200	225.00
External smart battery charger	B-030-0000	245.00
Power adaptor (12 volts @ 2 Amps w/6' cable)	N-250-0001	95.00
Universal power cable	N-506-0060	15.00
Instrument case (w/straps)	F-250-0006	165.00
Operators manual DFX-8 (Thickness)	P-250-0003	20.00
Operators manual DFX-8 (Flaw)	P-250-0004	20.00
USB Type A to Type B male data cable	N-606-0530	25.00
RS232 PC cable (9 pin)	N-306-0410	75.00
USB to Serial Adapter	N-402-0510	25.00
Plastic Carrying Brief Case	A-250-6002	90.00
Lemo 00 to BNC Transducer Cable Adapter	J-098-0001	50.00
10' Lemo 1 5pin to BNC analog output cable	N-110-0470	90.00
10' Lemo 1 5pin to DB9 analog output cable	N-110-0410	80.00
Universal cable (5 pin Lemo 1 to BNC, 6' DB9, & 2 6' Alarm out)	N-306-0416	120.00

Couplant			
			
Part #	Description	Comments	Price US
V-000-0001	4 oz bottle		15.00
V-000-0003	12 oz bottle		25.00
V-000-0004	1 gallon		150.00
V-000-0002	2 oz tube (High Temp – 900F)		40.00

Educational Training Software (self-paced courses – CD's):	Part #	Price US
Ultrasonic Testing (UT)	UTEDU	1150.00
Advanced Ultrasonic Techniques – Phased Array & TOFD (PA)	PAEDU	575.00

DAKOTA ULTRASONICS
 1500 Green Hills Road, #107 Scotts Valley, CA 95066
 Phone: (831) 431-9722 Fax: (831) 431-9723 www.dakotaultrasonics.com
 Prices subject to change without notice: please call for an updated price list.

Penetrant Testing (PT)	PTEDU	350.00
Magnetic Testing (MT)	MTEDU	525.00
Radiographic Testing (RT)	RTEDU	1150.00
Corrosion Basic Principles (CO)	COEDU	575.00

TRANSDUCER CABLES & CABLE ADAPTORS



BNC	Lemo 1	Lemo 00 M	Lemo 00 F	Microdot
-----	--------	-----------	-----------	----------

Custom Lengths: Available on request.

Single probe cable (DFX-6 Series) – 6' length

Type	Part #	Price	Type	Part #	Price
BNC - BNC	N-106-0170	60.00	LEMO 1 - LEMO 00	N-106-0800	90.00
BNC - LEMO 00	N-106-0100	65.00	LEMO 1 - LEMO 1	N-106-0830	115.00
BNC - M'DOT	N-106-0120	65.00	LEMO 1 - M'DOT	N-106-0820	90.00
BNC - LEMO 1	N-106-0130	85.00			

Dual probe cable (DFX-6 Series) – 6' length

Type	Part #	Price	Type	Part #	Price
BNC - M'DOT	N-206-0120	100.00	LEMO 1 - LEMO 00	N-206-0800	145.00
BNC - LEMO 00	N-206-0100	105.00	LEMO 1 - M'DOT	N-206-0820	150.00

Single probe cable (DFX-7 Series) – 4' length

Type	Part #	Price	Type	Part #	Price
LEMO 00 - M'DOT	N-104-0020	65.00	LEMO00 - LEMO00	N-104-0000	65.00
LEMO 00 - BNC	N-104-0070	60.00			

Dual probe cable (DFX-7 Series) – 4' length

Type	Part #	Price	Type	Part #	Price
LEMO 00 - M'DOT	N-204-0020	100.00	LEMO00 - LEMO00	N-204-0000	100.00
LEMO 00 - BNC	N-204-0070	95.00			

Single probe cable (DFX-8 Series) – 6' length

Type	Part #	Price	Type	Part #	Price
LEMO 00 - M'DOT	N-106-0020	70.00	LEMO00 - LEMO00	N-106-0000	70.00
LEMO 00 - BNC	N-106-0100	65.00			

Dual probe cable (DFX-8 Series) – 6' length

Type	Part #	Price	Type	Part #	Price
LEMO 00 - M'DOT	N-206-0020	110.00	LEMO00 - LEMO00	N-206-0000	110.00
LEMO 00 - BNC	N-206-0100	105.00			

TRANSDUCERS

SINGLE ELEMENT CONTACT TRANSDUCERS (SLM) – HIGH WEAR																
																
<table border="1" style="width: 100%; border-collapse: collapse;"> <thead> <tr> <th style="padding: 5px;">Element Size (Dia.)</th> <th style="padding: 5px;">A</th> <th style="padding: 5px;">B</th> </tr> </thead> <tbody> <tr> <td style="padding: 5px;">.500"</td> <td style="padding: 5px;">1.055"</td> <td style="padding: 5px;">1.230"</td> </tr> <tr> <td style="padding: 5px;">.750"</td> <td style="padding: 5px;">1.268"</td> <td style="padding: 5px;">1.430"</td> </tr> <tr> <td style="padding: 5px;">1.00"</td> <td style="padding: 5px;">1.555"</td> <td style="padding: 5px;">1.430"</td> </tr> </tbody> </table>	Element Size (Dia.)	A	B	.500"	1.055"	1.230"	.750"	1.268"	1.430"	1.00"	1.555"	1.430"				
Element Size (Dia.)	A	B														
.500"	1.055"	1.230"														
.750"	1.268"	1.430"														
1.00"	1.555"	1.430"														
Description:	High wear/resolution contact transducers with extended stainless steel ring.															
Used:	Rough surfaces, Castings, Billets, and Extruded Parts.															
Damping:	Medium															
Connectors:	BNC (B), Lemo 1 (L) *Specify connector type after part #															
Price:	\$325.00 US **\$415.00 or ***\$385.00 (P) Composite option – 1MHz & 3.5MHz only available with Composite. ***Call for price on 3.5MHz.															
Element Size	**1.0 MHz	2.25 MHz	***3.5 MHz	5.0 MHz												
.500" DIA. (a)	PSLM501	SLM5025	PSLM5035	SLM5050												
.750" DIA.	PSLM751	SLM7525	PSLM7535	SLM7550												
1.00" DIA.	PSLM101	SLM1025	PSLM1035	SLM1050												
Ordering Example: SLM7525B = SLM .750" x 2.25MHz BNC																

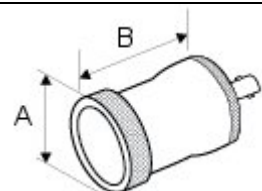
SINGLE ELEMENT CONTACT TRANSDUCERS (SLF) – MEMBRANE													
													
<table border="1" style="width: 100%; border-collapse: collapse;"> <thead> <tr> <th style="padding: 5px;">Element Size (Dia.)</th> <th style="padding: 5px;">A</th> <th style="padding: 5px;">B</th> </tr> </thead> <tbody> <tr> <td style="padding: 5px;">.500"</td> <td style="padding: 5px;">1.250"</td> <td style="padding: 5px;">1.180"</td> </tr> <tr> <td style="padding: 5px;">1.00"</td> <td style="padding: 5px;">1.500"</td> <td style="padding: 5px;">1.580"</td> </tr> </tbody> </table>	Element Size (Dia.)	A	B	.500"	1.250"	1.180"	1.00"	1.500"	1.580"				
Element Size (Dia.)	A	B											
.500"	1.250"	1.180"											
1.00"	1.500"	1.580"											

DAKOTA ULTRASONICS
 1500 Green Hills Road, #107 Scotts Valley, CA 95066
 Phone: (831) 431-9722 Fax: (831) 431-9723 www.dakotaultrasonics.com
 Prices subject to change without notice: please call for an updated price list.

Description:	Replaceable membrane protected contact transducers.			
Used:	Rough surfaces, Castings (provides better contact).			
Damping:	High Gain			
Connectors:	BNC			
Price:	\$360.00 US **\$425.00 (P) Composite option - 1MHz & 3.5MHz only available with Composite. ***\$400.00 (P) Composite option.			
Element Size	**1.0 MHz	***2.25 MHz	**3.5 MHz	***5.0 MHz
.500" DIA.	PSLF501	SLF5025	PSLF5035	SLF5050
1.00" DIA.	PSLF101	SLF1025	PSLF1035	SLF1050
Ordering Example: SLF101 = SLF 1.00" x 1.0 MHz				

SINGLE ELEMENT CONTACT TRANSDUCERS (FC) – FINGER TIP



Description:	General contact style transducers with stainless steel construction. Good for near surface resolution with a 70% bandwidth.				
Used:	Common metals, plastics				
Damping:	High gain (G), Resolution (R) *Specify damping after (FC), No Damping on 1MHz or 3.5MHz - Composite.				
Connectors:	Microdot Side Entry *Optional top connect (T)				
Price:	\$320.00 US or **\$385.00. 1MHz & 3.5MHz only available with Composite. \$360.00 (P) Composite option. *Specify connector mount after part #				
Element Size	1.0 MHz	2.25 MHz	3.5 MHz	5.0 MHz	**10.0 MHz
.250" DIA.	-	FC2525	PFC2535	FC2550	FC2510
.375" DIA.	-	FC3725	PFC3735	FC3750	FC3710
.500" DIA.	PFC501	FC5025	PFC5035	FC5050	FC5010
Ordering Example: FCR5025T = FC Resolution .500" x 2.25MHz TOP MOUNT					

SINGLE ELEMENT CONTACT TRANSDUCERS (FCSL) – FINGER TIP (SLIM LINE)



Description:	Line high frequency general contact transducers with a stainless steel housing.
Used:	Common metals, plastics

Damping:	High Damped			
Connectors:	Microdot Side Entry *Optional top connect (T), Specify after part #			
Price:	See below			
Element Size	5.0 MHz	10.0 MHz	15.0 MHz	20.0 MHz
Price	\$365	\$390	-	-
.125" DIA.	FCSL1250	FCSL1210	FCSL1215	FCSL1220
Ordering Example: FCSL1250T = FCSL .125" x 5MHz w/top entry microdot				

STANDARD SHEAR WAVE TRANSDUCERS (SS)



Element Size (Dia.)	A	B	C	D
.500" x .500"	.650"	.750"	1.125"	.810"
.500" x 1.00"	.650"	.750"	1.625"	1.312"
.625" x .625"	.650"	.850"	1.350"	1.000"
.750" x .625"	.650"	.850"	1.350"	1.000"
.750" x .750"	.650"	.910"	1.350"	1.000"

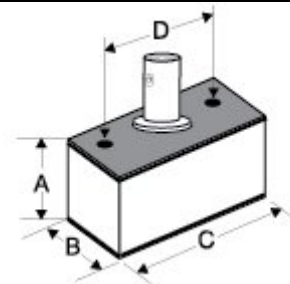

Description:	Shear wave transducers designed to use a variety of angle beam wedges for general weld inspection & A.W.S, and constructed in a low noise plastic or stainless steel housing.		
Used:	General weld inspection.		
Damping:	High gain (G), Resolution (R) *Specify damping after (SS), No damping on 1MHz - Composite.		
Connectors:	BNC (B), Microdot (M) *Specify connector after part #		
Price:	\$320.00 US **355.00 (P) Composite (2.25MHz AWS)		
Element Size	**1.0 MHz	2.25 MHz	5.0 MHz
.500" x .500"	PSS50501	SS50502	SS50505
.500" x 1.00"	PSS50101	SS50102	SS50105
.625" x .625"	PSS62621	**PSS62622 / SS62622	**PSS62625 / SS62625
.625" x .750"	PSS62751	**PSS62752 / SS62752	**PSS62755 / SS62755
.750" x .750"	PSS75751	SS75752	SS75755
Ordering Example: SSG50502 = SS High Gain 1/2" x 1/2" 2.25MHz			

DAKOTA ULTRASONICS
1500 Green Hills Road, #107 Scotts Valley, CA 95066
Phone: (831) 431-9722 Fax: (831) 431-9723 www.dakotaultrasonics.com
Prices subject to change without notice: please call for an updated price list.

STANDARD WEDGES (SW)



Price: \$42.50 US

Angle Beam Wedges – Custom angles available on request.

Element Size	45°	60°	70°
.500" x .500"	SW5045	SW5060	SW5070
.500" x 1.00"	SW5145	SW5160	SW5170
.625" x .625"	SW6245	SW6260	SW6270

Note: An additional \$10 will be charged to radius edges.

Ordering Example: SW5045 = SW 1/2" x 1/2" 45 Degree steel

SERRATED (AWS TYPE) SQUARE WEDGES (SQW)



Price: \$52.50 US

Angle Beam Wedges – Custom angles & radius available on request.

Element Size	45°	60°	70°
.625" x .625"	SQW6245	SQW6260	SQW6270
.625" x .750"	SQW6245	SQW6260	SQW6270

Note: An additional \$10 will be charged to radius edges.

Ordering Example: SQW6245 = SQW 5/8" x 5/8" 45 Degree steel

SNAIL (AWS TYPE) WEDGES (SNW)

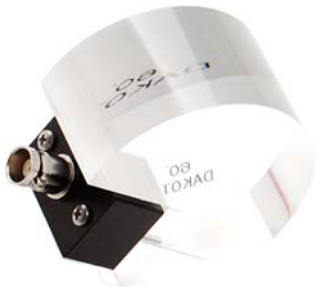

Price: \$52.50 US

Angle Beam Wedges – Custom angles & radius available on request.			
Element Size	45°	60°	70°
.625" x .625"	SNW6245	SNW6260	SNW6270
Note: An additional \$10 will be charged to radius edges.			
Ordering Example: SNW6245 = SNW 5/8" x 5/8" 45 Degree steel			

QUICK CHANGE SHEAR WAVE TRANSDUCERS (QC)



Description:	Threaded shear wave transducers for quickly interchanging between wedges. Ideal for limited access and curved surfaces.
Used:	General weld inspection
Damping:	High gain (G), Resolution (R) *Specify damping after (QC), No damping on 3.5MHz
Connectors:	Microdot
Price:	\$320.00 **\$340.00 US

Standard (Q)					
Element Size	1.0 MHz	2.25 MHz	3.5 MHz	5.0 MHz	**10.0 MHz
.250" DIA.	-	QC2525	-	QC2550	QC2510
.375" DIA.	-	QC3725	-	QC3750	QC3710
.500" DIA.	-	QC5025	-	QC5050	QC5010

Ordering Example: QCR2510 = QC Resolution .250" x 10MHz

Price:	\$340.00 US
---------------	--------------------

Composite (P)					
Element Size	1.0 MHz	2.25 MHz	3.5 MHz	5.0 MHz	10.0 MHz
.250" DIA.	PQC251	PQC2525	-	PQC2550	PQC2510
.375" DIA.	PQC371	PQC3725	-	PQC3750	
.500" DIA.	PQC501	PQC5025	PQC5035	PQC5050	

Ordering Example: PQC2510 = QC Composite .250" x 10MHz

STANDARD QUICK CHANGE WEDGES (QW)



Price: \$42.50 US

Quick Change Wedges – Custom angles available on request.

Element Size	45°	60°	70°
.250" DIA.	QW2545	QW2560	QW2570
.375" DIA.	QW3745	QW3760	QW3770
.500" DIA.	QW5045	QW5060	QW5070

Ordering Example: QW2545 = QW .250" 45 Degree

QUICK CHANGE AWS PROVE UP SHEAR WAVE TRANSDUCERS (QCA)



Description: Removable shear wave transducers for quickly interchanging between wedges. Ideal for limited access, curved surfaces, and AWS prove up.

Used: General weld inspection

Damping: High Damped

Connectors: Microdot

Price: \$385.00 **\$425 US ***AWS

Element Size	**1.0 MHz	***2.25 MHz	5.0 MHz
.625" x .625"	PQCA62621	QCA62622	QCA62625

Ordering Example: QCA62622 = QCA .625" x .625" 2.25MHz Microdot

QUICK CHANGE AWS PROVE UP WEDGES (QAW)



Price: \$52.50 US

Angle Beam Wedges – Custom angles & radius available on request.

Element Size	45°	60°	70°
.625" x .625"	QAW6245	QAW6260	QAW6270

Note: An additional \$10 will be charged to radius edges.

Ordering Example: QAW6245 = SNW 5/8" x 5/8" 45 Degree Steel

DUAL SHEAR WAVE TRANSDUCERS (CDA)



Description: Designed for thin material and weld inspections that require near surface resolution. Will Detect of IGSCC (Inter Granular Stress Corrosion Cracking).

Used: Weld inspection

Damping: Medium Damped

Connectors: Microdot End (E) or Top (T) connect *Specify after part #

Price: \$575.00 US **625.00 (P) Composite option – 1MHz only available with Composite.

Element Size	**1.0 MHz	2.25 MHz	5.0 MHz
.250" x .250"	PCDA251	CDA2525	CDA2550
.250" x .375"	PCDA25371	CDA253725	CDA253750
.375" x .375"	PCDA371	CDA3725	CDA3750
.500" x .500"	PCDA501	CDA5025	CDA5050

Ordering Example: CDA252560T = CDA 1/4" x 1/4" 2.25 MHz, 60 Degree Top Connector.

CDA ANGLE OPTIONS – NOT INTERCHANGEABLE

Element Size	45°	60°	70°
--------------	-----	-----	-----

DAKOTA ULTRASONICS

1500 Green Hills Road, #107 Scotts Valley, CA 95066

Phone: (831) 431-9722 Fax: (831) 431-9723 www.dakotaultrasonics.com

Prices subject to change without notice: please call for an updated price list.

ALL	ADD 45 TO PT#	ADD 60 TO PT#	ADD 70 TO PT#
-----	---------------	---------------	---------------

MINIATURE ANGLE BEAM POTTED (MAP)	
	
Description:	Mini angle beam transducers with a fixed angle. Stainless steel Housing, all angles are in steel, aluminum angle available on request.
Used:	Weld inspection (tight areas).
Damping:	Medium Damped
Connectors:	Microdot Side Entry
Price:	\$315.00 US **\$335.00 US

Element Size	2.25 MHz			5.0 MHz		
	45°	60°	70°	45°	60°	70°
.187" DIA.	MAP 182545	MAP 182560	MAP 182570	MAP 185045	MAP 185060	MAP 185070
.250" DIA.	MAP 252545	MAP 252560	MAP 252570	MAP 255045	MAP 255060	MAP 255070
** .375" DIA.	MAP 372545	MAP 372560	MAP 372570	MAP 375045	MAP 375060	MAP 375070

Element Size	**10.0 MHz		
	45°	60°	70°
.187" DIA.	MAP 181045	MAP 181060	MAP 181070
.250" DIA.	MAP 251045	MAP 251060	MAP 251070
.375" DIA.	MAP 371045	MAP 371060	MAP 371070

MINI MINIATURE ANGLE BEAM POTTED (MMAP) – DIM .375”L x .250”W x .37”H	
	
Description:	Mini miniature angle beam potted transducers with a fixed angle, are designed with stainless steel Housing for durability. Standard angles are in steel, all other non-standard angles with specific materials can be produced.
Used:	Weld inspection (tight areas).
Damping:	Medium Damped
Connectors:	Microdot Side Entry
Price:	\$420.00 US **\$445.00 US

Element Size	5.0 MHz			**10.0 MHz		
	45°	60°	70°	45°	60°	70°
.187" DIA.	MMAP 185045	MMAP 185060	MMAP 185070	MMAP 181045	MMAP 181060	MMAP 181070

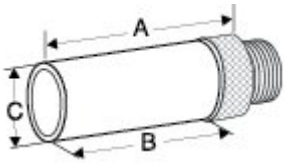
IMMERSION TRANSDUCERS (IM)					
					
Element Size (Dia.)	A	B	C	D	
.250"	Custom Only				
.375"	1.75"	1.40"	.525"		
.500"	1.75"	1.40"	.625"		
.750"	1.75"	1.00"	1.00"		
					
Description:	Designed for immersion tank or bubbler system inspections. Stainless steel housing with UHF connector. Three different lens configurations are available – Flat, Spherical focus and Cylindrical focus.				
Used:	Immersion and bubbler inspections				
Damping:	High Gain (G), Resolution (R), and High Resolution (HR), No damping on 1MHz (P) Composite Option Only.				
Connectors:	UHF				
Price:	\$315.00 US **\$340 US ***\$420.00 Add: \$50.00 for focusing (HR)				
Note: Specify damping after (IM), Lens configuration, or focal length when placing order.					
Note: Higher frequencies available upon request.					
Element Size	1.0 MHz	2.25 MHz	5.0 MHz	**10.0 MHz	***15.0 MHz
.250" DIA.	-	IM2525	IM2550	IM2510	IM2515
.375" DIA.	-	IM3725	IM3750	IM3710	-
.500" DIA.	PIM501 (\$370.00)	IM5025	IM5050	IM5010	-
.750" DIA.	PIM751 (\$395.00)	IM7525	IM7550	IM7510	-
1.00" DIA.	PIM101 (\$420.00)	IM1025	IM1050	-	-
Ordering Example: IMR7550 = IM Resolution .750" 5MHz					

Thickness Gauge Transducers	
Dual Element:	All thickness gauge transducers are compatible with our flaw detectors. Refer to the thickness gauge transducer catalog for additional information on available diameters, frequencies, and connector types.
Delay Line:	Same as above
Pencil (Delay line):	Same as above

Dual Element Transducers



**Refer to the thickness gauge price sheet for additional information and pricing.

Delay Line & Pencil Transducers



**Refer to the thickness gauge price sheet for additional information and pricing.

ULTRASONIC TEST AND CALIBRATION BLOCKS

BLOCK TYPE	STEEL	7075 AL	304 SS	TITANIUM	CASE
					
IIW TYPE 1 – per institute of welding (IIW), ASTM-E-164 & MIL-STD-2154	\$545	\$545	\$920	\$1640	\$95
Application – Calibration of transverse and longitudinal wave distance setting determination of the sound beam point of incidence and exact angle of propagation. Geometry – 1" x 4" x 12". Contains 2" dia. hole and 4" radius. Also 1/8" x 1" radius alternate reflector 1/16" deep on echo side.					

					
IIW TYPE 2 – per IIW & USAFTO 33 B-1-1 (6-1-84)	\$630	\$630	\$1070	\$1920	\$95
Application – Modified version of IIW Type 1, with a 2" radius ¼" deep cut out test side, and 3 extra side drilled resolution holes.					

					
IIW V-1 (METRIC) – (European version of IIW) per BS-2704	\$545	\$600	\$1015	\$1640	\$95

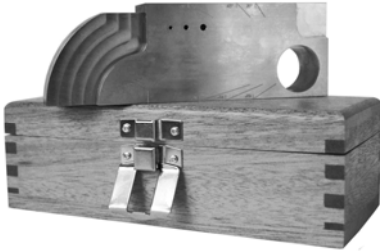
					
MINI IIW	\$605	\$605	\$895	\$1610	\$95

Application – Miniature version of IIW type blocks resembling the Type 2.
Geometry – 1" x 2" x 6". Contains 1" diameter hole, 2" radius ¼" deep cut out test side 3 side drilled resolution holes, and ¾" sq. x .100" deep cut out.

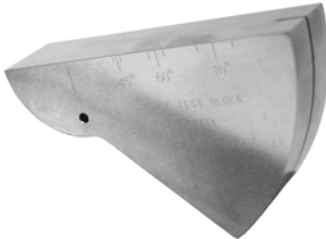
BLOCK TYPE	STEEL	7075 AL	304 SS	TITANIUM	CASE
					

DSC – per AWS & ATM-E-164 \$380 \$380 \$680 \$1220 \$55

Application – Shear wave distance and sensitivity calibration.
Geometry – 1" thick, 4" long with 1" radius and 3" radius. Contains a 3/8" deep x 1/32" radius notch and a ½" dia. side drilled hole for 45, 60, & 70 degrees.



DS –DISTANCE & SENSITIVITY
per ANSI / AWS \$775 \$775 \$1240 \$2235 \$115

Application – Distance and sensitivity.
Geometry – 2" x 2" x 6" with a 2" wide cutout.



ANGLE BEAM (ROMPAS) -
per ASTM-E-164 & USAFTO
33 B-1-1 (6-1-84) - Kidney \$305 \$305 \$505 \$900 \$50

Application – Angle beam calibration.
Geometry – ½" or 1" thick, 1" radius opposite 2" radius with 5/64" dia. by ¾" deep flat bottom hole (1" thick only).

ANGLE BEAM (V-2) METRIC
20MM or 12.5MM (Euro)
Target hole 5MM or 1.5MM \$305 \$305 \$505 \$905 \$50

ANGLE BEAM (V-2) METRIC
25MM (Euro)
Target hole 5MM or 1.5MM \$335 \$335 \$555 \$995 \$50

Application – Angle beam calibration.
Geometry – European version of Angle Beam calibration block. Optional 20mm or 12.5mm versions with 5mm or 1.5mm target hole.

BLOCK TYPE	STEEL	7075 AL	304 SS	TITANIUM	CASE
					
ANSI/AWS RESOLUTION - RC	\$310	\$310	\$530	\$950	\$50
Application – Checking resolution capabilities of angle beam transducers. Per AWS and BPR. Geometry – 1" x 3" x 6". Contains nine .062" dia. holes for 45, 60, and 70 degrees.					

					
SC – per AWS / ASTM-E-164	\$195	\$195	\$360	\$650	\$45
Application – Sensitivity calibration (shear wave). Geometry - .905" x 1.25" x 3". Contains two .062" diameter side drilled holes.					

					
DC – per AWS & ASTM-E-164	\$285	\$285	\$495	\$895	\$50
Application – Distance calibration (shear wave). Geometry – 1" radius overlying 2" radius on 180 degree half circle.					

					
IOW BEAM PROFILE – English or metric. Per BS2704 (British Standards).	\$695	\$695	\$1180	\$2120	\$90
Application – Beam profile measurement of angle beam transducer. Geometry – 2" x 3" x 12". Contains two 1/16" diameter x 7/8" deep calibration holes on far side. Also contains five 1/16" diameter resolution holes drilled on 10 degree slope, far side only.					

BLOCK TYPE	STEEL	7075 AL	304 SS	TITANIUM	CASE	
						
NAVSHIPS – per NAVSEA T 9074-AS-GIB-010/271 formerly Navships 0900-006-3010Sec. 6 & MIL STD-271F		\$530	\$530	\$915	\$1650	\$90
Application – Distance correction and sensitivity levels. Geometry – 1 ¼" x 3" x 12". Contains seven 3/64" dia. side drilled holes at distances of 1/8" through 2 ¾".						

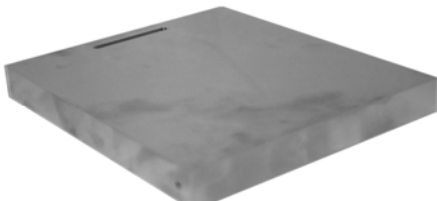
						
ASME ref. block .75" – per ASME SEC V Article 23 T-434.2.1		\$490	\$490	\$660	\$1190	\$110
Application – Angle beam calibration Geometry – 1" or less – ¾" x 6" x 7"						
ASME ref. block 1.50" – per ASME SEC V Article 23 T-434.2.1		\$780	\$780	\$970	\$1945	\$145
Application – Angle beam calibration Geometry – Over 1" through 2" – 1.5" x 6" x 10"						
ASME ref. block 3.0" – per ASME SEC V Article 23 T-434.2.1		\$1175	\$1175	\$1470	\$2935	call
Application – Angle beam calibration Geometry – Over 2" through 4" – 3" x 6" x 12"						

						
ASME-N-625 ref. plate - Per ASME 1275N B.P., Section 3, Nuclear Vessels		\$640	\$640	\$1135	\$2040	\$90
Application – For longitudinal shear and surface wave sensitivity calibration. Geometry – ½" x 6" x 12". Contains 5 flat bottom holes and 1 thru hole; 3 each .062" diameter holes at depths of .050", .250" and thru. One .062" diameter hole at 1.5" depth; .125" diameter hole at 1.625" depth; one .250" diameter hole at 1.750" depth. Also contains one .002" deep surface wave notch.						

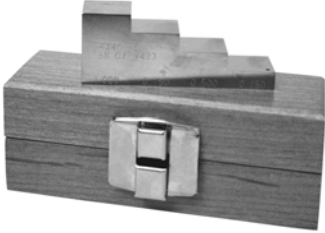
BLOCK TYPE	STEEL 1018	STEEL 4340	7075 AL	304 SS	TITANIUM	CASE
						
4-STEP BLOCK per ASTM-E-797 Part# X-000-0002	\$205	\$205	\$205	\$460	\$520	\$50
Application – Thickness and linearity calibration.						
Geometry – .750" square with thickness of .250", .500", .750", and 1.0".						

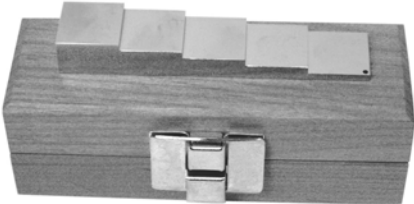
						
5-STEP BLOCK – per ASTM-E-797 Part# X-000-0001	\$205	\$205	\$205	\$460	\$520	\$50
Application – Thickness and linearity calibration.						
Geometry – .750" square with thickness of .100", .200", .300", .400", and .500".						

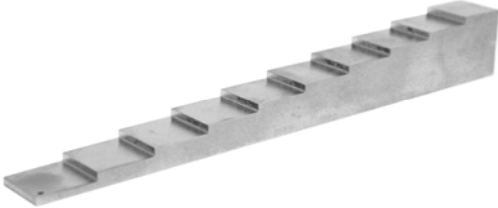
						
10-STEP BLOCK – per ASTM-E-797 Part# Custom	\$455	\$455	\$910	\$1090	\$130	
Application – Thickness and linearity calibration.						
Geometry – .750" square with thickness of .100" thru 1.0".						

*Additional calibration standards and test blocks available in other material types – Call